

EQUILIBAR®

PRECISION FLUID CONTROL

5X MORE
PRECISE
than standard
regulators



GS Series

¼" – 1" Back Pressure Regulators
FOR GAS, LIQUID, AND MIXED PHASE SERVICE

5X MORE
PRECISE
than standard
regulators

The Equilibar Difference

Our performance.

Equilibar® back pressure regulators outperform the competition, particularly in applications with low flow rates, mixed phase fluids, corrosive media, or extreme temperatures.

Our people.

Every inquiry gets focused attention from our engineering team to determine the best possible product for your needs. Every back pressure regulator is hand assembled and tested to meet our stringent quality standards.

Our priorities.

Our goal is to exceed your expectations. In an industry where delivery times frequently exceed 6 weeks, we offer many of our standard products with delivery in about two weeks.

Traditional back pressure regulators set the upstream pressure with a spring. These designs utilize sliding seals and other moving parts that can introduce hysteresis and other undesired effects into a process. The Equilibar® back pressure regulator uses a thin, supple diaphragm as the only moving part. This allows frictionless operation without cracking pressure or hysteresis. The accuracy of the Equilibar® back pressure regulator is limited only by the accuracy of the pilot setpoint.



How It Works

Simply load the Equilibar® back pressure regulator with a pilot pressure equal to the desired back pressure and the Equilibar does the rest. This pressure forces the flexible diaphragm down onto a plate of orifices. A rise in inlet pressure lifts the diaphragm up to allow excess pressure to be relieved through the outlet orifices. Similarly, a loss of pressure at the inlet causes the diaphragm to be pushed closer to the orifices, restricting flow and rebuilding pressure upstream.

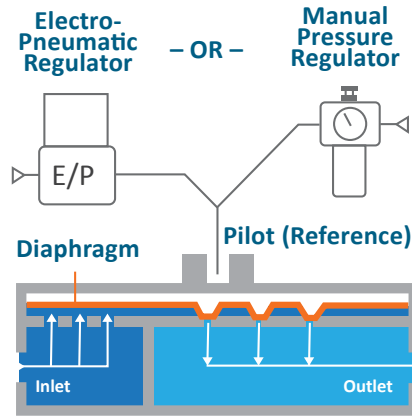

Pilot operate your Equilibar® back pressure regulator with an electronic pressure regulator for automated back pressure control.

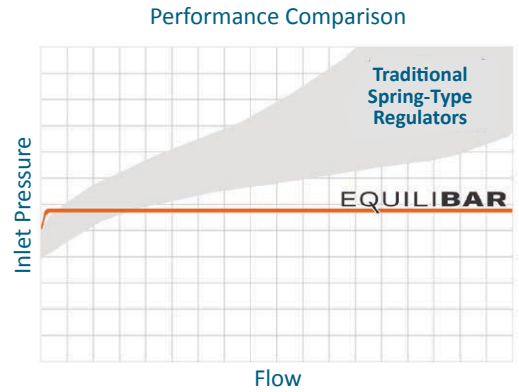

Or set the pilot pressure with a precision pressure reducing regulator for manual control.

Manual and electronic pilot regulators are sold separately

TYPE	PRESSURE REDUCING REGULATOR	BACK PRESSURE REGULATOR
SCHEMATIC		
CONTROLS PRESSURE	Downstream	Upstream
OPENS TO	Increase downstream pressure	Decrease upstream pressure
CLOSES TO	Decrease downstream pressure	Increase upstream pressure

BACK PRESSURE REGULATORS VS PRESSURE REDUCING REGULATORS

Pressure reducing regulators reduce a higher supply pressure at the inlet down to a regulated lower pressure at the outlet (downstream). Back pressure regulators work the opposite way. They regulate the inlet (upstream) pressure by opening up only as much as necessary to hold back the desired pressure at the inlet (upstream).

Controlling Pump Output Pressure

A common application for a back pressure regulator is shown in the schematic at right. A pump cannot build discharge pressure unless there is resistance on its outlet piping. A properly sized back pressure regulator can create just the necessary amount of resistance to accurately control pump discharge pressure.

Note that the concept of pressure bypass control works equally well for all types of pumps (i.e. centrifugal pumps as well as positive displacement pumps). When used this way, a back pressure regulator is also referred to as a pressure sustaining valve or pressure bypass valve.

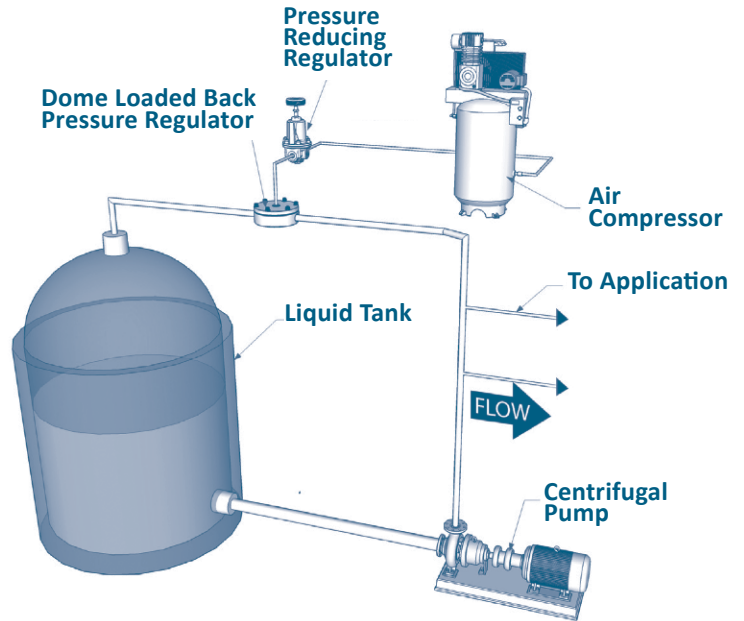

Precision Low Pressure Gas Delivery Tubing Extrusion Systems

Tubing extrusion is an example of an application where very low pressure control is required across widely varying flow rates. It is difficult to identify a pressure reducing regulator or automated control valve that can respond with adequate speed and precision in this range below 0.5 psig (34 mbar).

Equilibar® precision back pressure regulators are frequently used for these extrusion control applications because of their high sensitivity in this low pressure range. When the GS Series BPRs are fitted with highly sensitive diaphragms, they can control pressure down to the range of 0.03 psig (2 mbar). In the schematic below, a flow controller, such as a rotameter, is used to establish a flow rate greater than the maximum required for the application. The back pressure regulator is set to vent off all flow greater than what is required to maintain the application at its precise set-point pressure. This approach is especially useful in applications where bidirectional pressure control is needed (both supplying to and venting flow from the application).

The Equilibar back pressure regulator can receive its 1:1 set-point pressure from either a small manual pressure regulator (such as the Equilibar LPR2, as shown) or from an electronic pressure regulator (such as the Equilibar QPV).

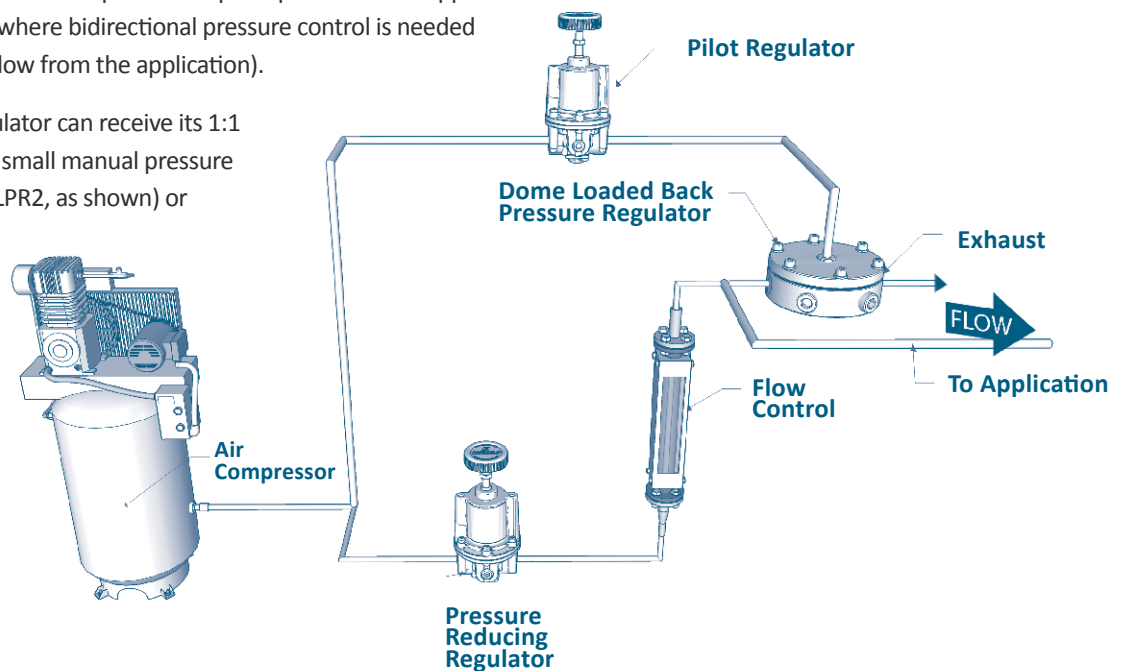

Fuel Pump, Fuel Injector and Fuel Rail Testing

In fuel system component testing, it is desirable to perform development and quality assurance tests at or close to actual operating conditions. This means varying the back pressure and the rpm of the unit(s) during the testing cycle. Varying speed is a well known process, but varying back pressure may get complicated or costly. Equilbar back pressure regulators can simplify the design of the test rig and provide reliable performance under high cycle service.

In the schematic below, the pump under test provides flow to an Equilbar back pressure regulator which has a pneumatic

pilot signal from an electro-pneumatic controller driven by a test computer with the desired rpm, flow, and pressure sequences. The tests can simulate the actual service conditions of varying loads and speeds, enabling a better prediction of performance in use. The same test stand can be used for quality assurance product tests.

Benefits: The pressures can be modulated rapidly to create high-cycle lifetime tests in a relatively short period of time, as the Equilbar regulator has a flexible diaphragm as its only moving part.

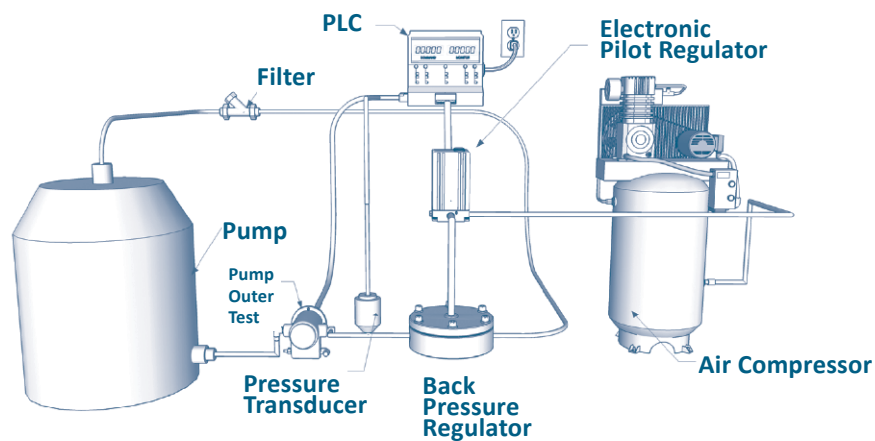

Back Pressure Regulators for Fuel Cells

The Equilbar® precision back pressure regulator is the perfect fit for many fuel cell applications. Fuel cell testing systems, in particular, benefit from the high sensitivity in the low to mid pressure ranges that is lacking in most competitive products. Equilbar's GR trim was designed in response to the demanding flow rate requirements of the fuel cell testing industry. These back pressure regulators can provide stable stack pressures through ultra wide flow rate ranges required for rigorous test protocols. Gas flow rate control is possible down to below 1 ml/minute. The superior low flow control results in an incredible 1000:1 flow rate turn-down ratio.

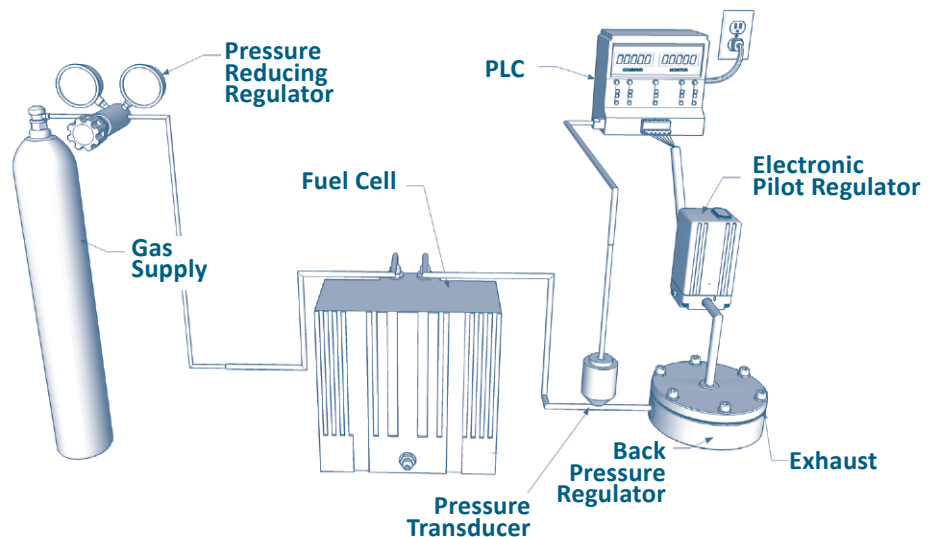

Our Key Performance Advantage

Traditional back pressure regulators use springs and sliding seals and develop overpressure with increasing flow as the spring is gradually compressed.

The Equilibar® back pressure regulator uses only a frictionless flexible diaphragm to modulate the pressure. It opens fully with minimal overpressure, is highly sensitive, and exhibits virtually no dead-band or hysteresis.

PRECISION OVER VARYING FLOW RANGES

The inlet pressure of most back pressure regulators varies significantly with changes in process flow.

The chart at right shows how the Equilibar GS/GSD regulator holds a constant process pressure even through widely varying flow rates. The GS/GSD regulator provides stable pressure control across flow ranges of 1000:1, and up to 10,000:1 in many applications.

LIQUID OR GAS APPLICATIONS

Unlike traditional pressure regulators, the GS Series is equally suited for liquid and gas applications.

The water performance curves at right show gradual pressure build above set-point as shear develops inside the regulator.

The logarithmic chart below shows excellent pressure stability down to very low flow rates. Because of this wide turn-down ratio, it is possible to size the Equilibar BPR for each application's required precision.

MIXED PHASE APPLICATIONS

Mixed phase applications cause problems for traditional pressure regulators because of the great variation in density between liquid and gas. However, the Equilibar BPR is able to process these density changes with minimal pressure disruption.



Ultra Wide Flow Range Performance
3/8" GSD3 Back Pressure Regulator

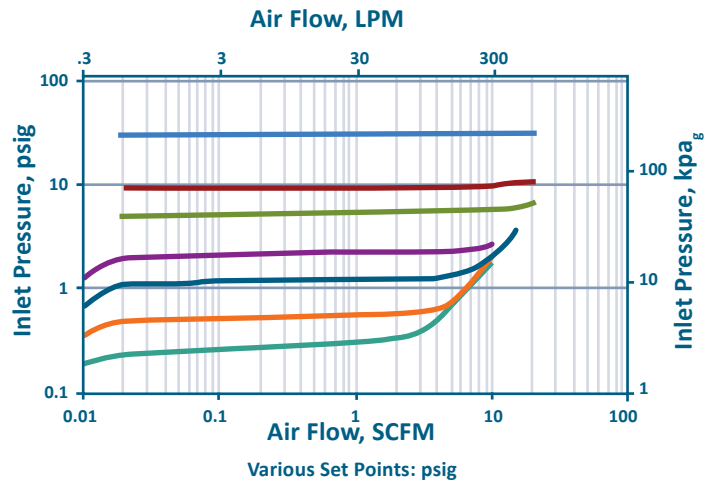

Water Performance - 1" GSD8

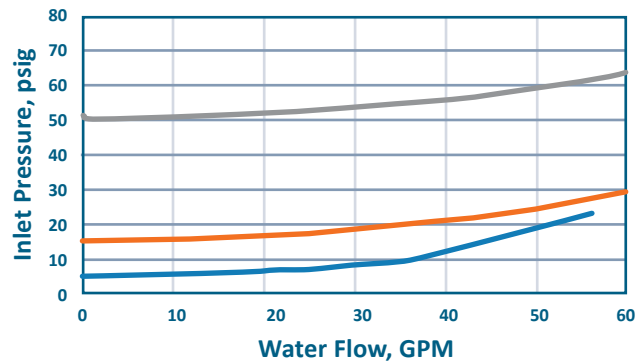

Wide Flow Range - 1" GSD8

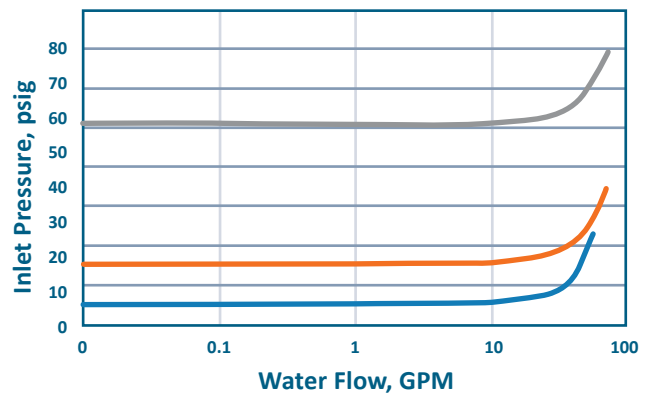

GS Series Back Pressure Regulators (Metal)

BASE PART #	MAX. PRESSURE RATING ¹	FLOW COEFF. (CV)		INLET / OUTLET PORT SIZE	REFERENCE PORT SIZE	PORT THREADS		DIM A	DIM B
		MIN	MAX			STANDARD	OPTIONAL		
	PSIG (BAR)							INCH (MM)	
Stainless Steel 316/316L, Hastelloy C276, Titanium, Monel and Zirconium Models									
GSD2/GS2	750 (51)	1E-03	1.20	1/4"	1/8"	N (NPT)	B, C, O, R, S, T	3.00 (76)	1.34 (34)
GSDM2	1000 (68)							3.25 (83)	1.34 (34)
GSDH2	2500 (172)							3.30 (84)	1.70 (43)
GSD3/GS3	400 (28)		1.80	3/8"				3.50 (89)	1.40 (36)
GSDM3	800 (55)							3.75 (95)	1.54 (39)
GSDH3	1400 (97)							3.85 (98)	1.78 (45)
GSD4/GS4	350 (24)	1E-02	3.20	1/2"	N (NPT)	B, C, F, G, O, R, S, T	4.50 (114)	1.73 (44)	
GSDM4	750 (52)						5.00 (127)	1.85 (47)	
GSDH4	1400 (97)						5.00 (127)	1.98 (50)	
GSD6/GS6	300 (21)	5.50	3/4"	1"			6.00 (152)	2.01 (51)	
GSDM6	700 (55)						6.25 (159)	2.44 (62)	
GSDH6	1600 (110)						6.40 (163)	2.90 (74)	
GSD8/GS8	150 (10)	1E-02	8.50	1"	7.00 (178)	2.50 (64)			
GSDM8	500 (34)				7.25 (184)	2.76 (70)			
GSDH8	2100 (145)				7.80 (198)	3.33 (85)			
Aluminum									
GSD2	400 (27)	1E-03	1.20	1/4"	1/8"	N (NPT)	B, C, T	3.00 (76)	1.34 (34)
GSD3	250 (17)		1.80	3/8"				3.50 (89)	1.40 (36)
GSD4	200 (13)		3.20	1/2"				4.50 (114)	1.73 (44)
GSD6	150 (10)	1E-02	5.50	3/4"	1"	N (NPT)	B, C, T	6.00 (152)	2.01 (51)
GSD8	75 (5)		8.50	1"				7.00 (178)	2.50 (64)

¹ Maximum pressure rating listed in this table is based on operating at 300 °C. Max pressure ratings will change depending on temperature. Speak to an application engineer.

PORTING OPTIONS	
NOTATION	TYPE
N	NPT (standard)
B	BSPP
C	Custom
F	150# Flange
G	300# Flange
O	Swagelok VCO®
R	Swagelok VCR®
S	SAE
T	Tube stub

TECHNICAL SPECIFICATIONS	
Max Operating Pressure	Pressure ratings listed in the table are the maximum possible pressure that a unit may be configured to. Units can be configured for optimum performance at lower pressures. Speak with an application engineer for more information.
Proof Pressure	150 % Rated Pressure ²
Design Pressure	400 % Maximum Body Pressure ³
Temperature Rating	Up to 150 °C (Metal Body, PTFE Diaphragm, Viton® O-Rings) Up to 200 °C (Metal Body, Metal Diaphragm, Viton® O-Rings) Up to 300 °C (Metal Body, Metal Diaphragm, Kalrez® O-Rings)

² All Equilbar units are tested to 150% of their rated pressure prior to shipment.

³ Designed according to ASME B31.3, which incorporates a 4X safety factor.

WETTED MATERIALS	
Body Material	Stainless Steel 316/316L (standard) Also available: Hastelloy C276, Titanium, Zirconium
O-Rings	Viton® (FKM) (standard) Also available: Kalrez® (FFKM), PTFE, EPDM, Buna-N
Diaphragm	PTFE/Glass Laminate (standard) Also available: Stainless Steel SS316/316L, Hastelloy C276, Virgin PTFE, FKM, Polyimide, Buna-N, PEEK, EPDM

Viton® and Kalrez® are registered trademarks of DuPont. VCO® and VCR® are trademarks of Swagelok.

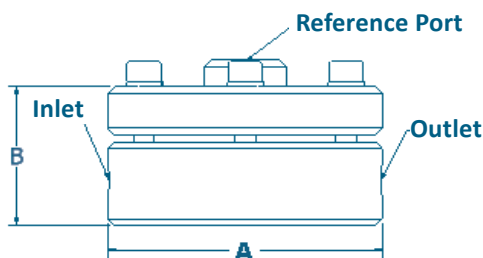

Fig. 1: Drawing For Reference

GS Series Back Pressure Regulators (Polymer)

BASE PART #	MAX. PRESSURE RATING	FLOW COEFF. (CV)		INLET / OUTLET PORT SIZE	REFERENCE PORT SIZE	PORT THREADS		DIM A	DIM B
		MIN	MAX			STANDARD	OPTIONAL		
	PSIG (BAR)							INCH (MM)	
PVC, CPVC, PVDF, and PEEK Models ¹									
GSD2/GS2	120 (8)	1E-03	1.20	1/4"	1/8"	N (NPT)	B, C, S, T	3.25 (83)	1.58 (40)
GSD3/GS3	100 (6)		1.80	3/8"				3.75 (95)	1.70 (43)
GSD4/GS4	75 (5)		3.20	1/2"				4.75 (121)	1.83 (46)
GSD6/GS6	50 (3)	1E-02	5.50	3/4"			B, C, F, S, T	6.25 (159)	2.34 (59)
GSD8/GS8	50 (3)		8.50	1"				7.25 (184)	2.93 (74)
PTFE Models									
GSD2/GS2	50 (3)	1E-03	1.20	1/4"	1/4"	N (NPT)	B, C, T	3.25 (83)	1.62 (41)
GSD3/GS3			1.80	3/8"				3.75 (95)	1.80 (46)
GSD4/GS4			3.20	1/2"				4.75 (121)	2.01 (51)
GSD6/GS6		1E-02	5.50	3/4"	6.25 (159)	2.50 (64)			
GSD8/GS8			8.50	1"	7.25 (184)	3.33 (85)			

¹ Polymer models not recommended for compressible gas applications.

PORTING OPTIONS	
NOTATION	TYPE
N	NPT (standard)
B	BSPP
C	Custom
F	150# Flange
G	300# Flange
S	SAE

TECHNICAL SPECIFICATIONS	
Max Operating Pressure	Pressure ratings listed in the table are the maximum possible pressure that a unit may be configured to. Units can be configured for optimum performance at lower pressures. Speak with an application engineer for more information.
Proof Pressure	150% Rated Pressure ²
Design Pressure	400% Maximum Body Pressure ³
Temperature Rating	Up to 40C (Polymer Body)

² All Equilibar units are tested to 150% of their rated pressure prior to shipment.

³ Designed according to ASME B31.3, which incorporates a 4X safety factor.

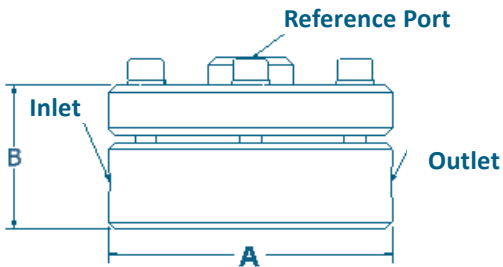

Fig. 2: Drawing For Reference



WETTED MATERIALS	
Body Material	PVC (standard) Also available: PTFE, PVDF, PEEK
O-Rings	Viton® (FKM) (standard) Also available: Kalrez® (FFKM), PTFE, EPDM, Buna-N
Diaphragm	PTFE/Glass Laminate (standard) Also available: Virgin PTFE, FKM, Polyimide, Buna-N, PEEK, EPDM

Viton® and Kalrez® are registered trademarks of DuPont. VCO® and VCR® are trademarks of Swagelok.

PATENTS

These regulators are subject to one or more of [these patents](#): US6,886,591, US7,080,660, US7,673,650, US8,215,336, DE60322443D1, GB1639282, FR1639282

Ordering Information

EXAMPLE																
GSD	2	S	N	X	-	N	S	X	P	100	T	150	G	X	VV	B
				X	-			X	P		T			X		
1	2	3	4	5	-	6	7	8		9		10	11	12	13	14

1 MODEL

GSD Standard O-Ring Design

GS No O-Ring Seals

GSDM Medium Pressure Models

GSDH High Pressure Models

2 PORT SIZE

2 1/4"

3 3/8"

4 1/2"

6 3/4"

8 1"

3 BODY MATERIAL

S Stainless Steel 316/316L

P PVC

A Aluminum (Anodized)

H Hastelloy C276

T Titanium

Z Zirconium

F PTFE

K PEEK

D PVDF

M Monel

4 PORT THREADS

N NPT

B BSPP

S SAE

O VCO®

R VCR®

F ANSI class 150 flanges

G ANSI class 300 flanges

5 MOD

Factory Selected

6 REFERENCE PORT THREADS

N NPT

B BSPP

S SAE

O VCO®

R VCR®

7 CAP MATERIAL

(Non Wetted)

S Stainless Steel 316/316L

P PVC

A Aluminum (Anodized)

H Hastelloy C276

T Titanium

Z Zirconium

F PTFE

K PEEK

D PVDF

M Monel

8 BOLTS

Factory Selected

9 PRESSURE RATING (PSIG)

This is the maximum pressure you would like your unit to be configured to accept. Must be equal to or less than the maximum rated pressure (in psig).

10 TEMPERATURE RATING (°C)

Temperature Limitations:

40 for most polymer bodies

150 for most PTFE diaphragms

200 for Viton O-rings

300 for Kalrez O-rings

11 DIAPHRAGM MATERIAL

G PTFE (Glass Reinforced)

B Buna-N (Nitrile)

V FKM Fluoroelastomer

M EPDM

E Polyethylene

F PTFE (Virgin)

S Stainless Steel 316/316L

H Hastelloy C276

I Polyimide

K PEEK

L Kel-F

Q Monel

12 DIAPHRAGM THICKNESS

Factory Selected

13 O-RING (GSD UNITS ONLY)

(Wetted)

VV Viton® Shore 75

WW Viton® Shore 90

KK Kalrez® Grade 7075

LL Kalrez® Grade 7090

FF PTFE

EE EPDM

BB Buna-N

14 SPECIAL OPTIONS

B Mounting Bracket (GSD2 & GSD3 in stock)

O Oxygen Cleaning

Options marked in blue are typically in stock for fast shipment

Viton® and Kalrez® are registered trademarks of DuPont.
VCO® and VCR® are trademarks of Swagelok.



Manual Pilot Control Options

Equilibrar precision back pressure regulators get their setpoint control signal using a fluid pressure called 'reference' or 'pilot' pressure on their top dome port. The reference pressure is set using a pressure reducing regulator or electronic pressure regulator sold separately.

You can supply your own pilot pressure regulator or choose one of the popular pilot setpoint regulators below and on the next page.

This page shows manual pressure reducing regulator options for a range of pressure conditions. Electronic pressure regulators for automated pressure control are described on the next page.



APPLICATION	SUPPLY PRESSURE	PORTS	EQUILIBAR PART NUMBER	OUTLET PRESSURE RANGE	REPEATABILITY & SENSITIVITY	
HIGH PRESSURE						
Series 3000 (High Pressure)		Max 10,000 psig	1/4" Inlet/Outlet Gauge	30-10082-2100-02-0	0 - 250 psig (17 bar)	Sensitive through a wide range of pressures
				30-10082-2110-02-0	5 - 500 psig (34 bar)	
				30-10082-2120-02-0	5 - 1000 psig (69 bar)	
				30-10082-2130-02-0	10 - 1500 psig (103 bar)	
				30-10082-2140-02-0	15 - 2500 psig (172 bar)	
				30-10082-2150-02-0	25 - 4000 psig (276 bar)	
				30-10082-2160-02-0	50 - 6000 psig (414 bar)	
				30-10082-2170-02-0	100 - 10,000 psig (690 bar)	
MEDIUM PRESSURE						
Model 10 (Medium Pressure)		Max 500 psig	1/4" NPT Inlet/Outlet Gauge	10212	0 - 2 psig (0.1 bar)	Sensitivity: Bleed option: .05% No-bleed option: ~ 0.2%
				10222	0 - 10 psig (0.7 bar)	
				10202	0 - 20 psig (1.4 bar)	
				10232	0.5 - 30 psig (2.0 bar)	
				10242	1 - 60 psig (4.1 bar)	
				10262	2 - 150 psig (10 bar)	
				10272	3 - 200 psig (14 bar)	
				10282	5 - 300 psig (21 bar)	
				10292	5 - 400 psig (28 bar)	
ULTRA LOW PRESSURE						
LPR2 Ultra Low Pressure Regulator		5 - 30 psig (Stable Regulated)	1/4" Inlet/Outlet (No Gauge)	LPR2-B-7	.25-7 in H2O (1-18 mbar)	Sensitivity: 0.02 in H2O Stability: 0.06 in H2O
				LPR2-B-10	1-10 in H2O (3-25 mbar)	
				LPR2-B-28	1-28 in H2O (3-70 mbar)	
				LPR2-NB-7	.25-7 in H2O (1-18 mbar)	
				LPR2-NB-10	1-10 in H2O (3-25 mbar)	
				LPR2-NB-28	1-28 in H2O (3-70 mbar)	

Electronic Pilot Control Options

Automating your process pressure is easily accomplished by using an electronic pressure regulator to provide the pilot setpoint pressure to the Equilibar dome-loaded back pressure regulator.

The electronic pressure control devices described below **and on our website** are custom tuned at the factory to work with Equilibar precision back pressure regulators or vacuum regulators.

Contact Equilibar or visit our website for additional details about the pilot pressure control options available for purchase.



REGULATOR	DESCRIPTION	KEY FEATURES
LOW PRESSURE - ULTRA PRECISION REGULATOR (150 PSIG MAX)		
QPV Series	 Control Pressures up to 150psig (10 Bar) with high resolution	<ul style="list-style-type: none"> Min range: 0.1 psig (7 mbar) Max range: 0-150 psig (10 bar) Available in gauge, absolute, vacuum and vacuum- positive ranges True proportional valve action Resolution: 0.005% - 0.2% FS 4-20mA and 0-10VDC analog I/O Optional DeviceNet or Serial Digital RS232/485
MEDIUM PRESSURE - PRECISION REGULATOR (500 PSIG MAX)		
QB Series	 Control Pressures up to 500psig (35 Bar)	<ul style="list-style-type: none"> Min range: vacuum; 0-1 psig (.07 bar) Max range: 0 -500 psig (34 bar) Available in gauge, absolute, vacuum and vacuum-positive ranges 0.2 to 0.5% FS accuracy 4-20mA and 0-10VDC analog I/O Optional DeviceNet or Serial Digital RS232/485
HIGH PRESSURE - PRECISION REGULATOR (1000 PSIG MAX)		
GP Series	 Directly Control 1000psig (69 Bar) Without a Ratio Amplifier	<ul style="list-style-type: none"> Max range: , 0 -1000 psig (69 Bar) Available in gauge, absolute, and vacuum-positive ranges 0.5% FS accuracy Field Serviceable

About Equilibar

Equilibar provides innovative and robust pressure control technology for researchers and engineers worldwide. We are proud to design, manufacture, and test our patented back pressure regulators in our factory overlooking the Blue Ridge Mountains near Asheville, NC.

APPLICATION ENGINEERING— WHAT SETS US APART

Unlike mass-market regulator distributors, we focus on working with you, the scientist or engineer with a complex pressure control scenario.

Our application engineers work collaboratively with clients to identify the optimal model, trim, and diaphragm for each application's unique challenges. No matter where you are on the globe, you can stay in close contact with your engineer by email, telephone, videoconferencing, or fax.

After installation, your application engineer will support you with start-up information and fine-tuning as needed.



Each application is reviewed by our engineering team to ensure quality performance of our products.

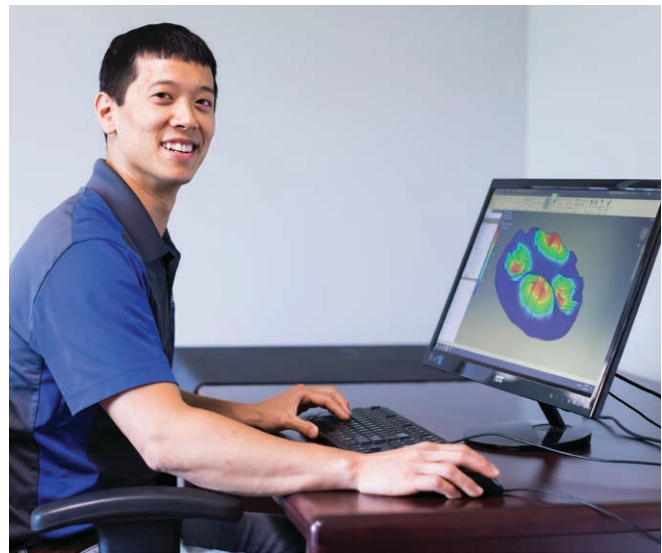

Our engineers offer custom designed solutions for the most difficult pressure control challenges. Feel free to contact us to discuss your situation.



Equilibar, LLC
320 Rutledge Rd.
Fletcher, North Carolina 28732
United States
Tel: +1-828-650-6590
Fax: +1-801-504-4439
Monday - Friday
8:00 AM - 5:00 PM EST
12:00 - 21:00 GMT
inquiry@equilibar.com



Made in the
USA

Equilibar's quality system is
ISO 9001:2015 certified.